

# INSTRUCTION MANUAL

**ORIGINAL INSTRUCTIONS  
FOR YOUR PERSONAL SAFETY,  
READ AND UNDERSTAND BEFORE USING.  
SAVE THESE INSTRUCTIONS FOR FUTURE REFERENCE.**



CE CB

# HOLE CUTTING DRILL

**Warning:**

**Only tools equipped with over load protection, when motor has been cut off due to over load, always switch on machine with no load for at least 3 minutes to reduce temperature before switch on again to avoid burn out to the motor.**

Power input	1100W
Voltage	See machine nameplate
No load min <sup>-1</sup>	130
Max. Cutting Capacity	Φ127mm
Pipe Mounting Capacity	Φ32-203 mm
Drill Chuck Capacity	1mm-16 mm
Over load protection	With
Soft Start	Without
Overall Dimensions ( LxWxH)	319 mm x 270 mm x 302 mm
Net Weight	14.5kg ( 31.9Lbs ) not include side Handle



Good balance for Carrying



On/off switch



Quickly mounts chain system

The quick adjustable tool-free lever

# GENERAL SAFETY INSTRUCTIONS



**WARNING! Read all safety warnings and all instructions.** Failure to follow the warnings and instructions may result in electric shock, fire and/or serious injury.

**Save all warnings and instructions for future reference.** The term "power tool" in the warnings refers to your mainsoperated (corded) power tool or battery-operated (cordless) power tool.

## 1) WORK AREA SAFETY

- a. **Keep work area clean and well lit.** Cluttered or dark areas invite accidents.
- b. **Do not operate power tools in explosive atmospheres, such as in the presence of flammable liquids, gases or dust.** Power tools create sparks which may ignite the dust or fumes.
- c. **Keep children and bystanders away while operating a power tool.** Distractions can cause you to lose control.

## 2) ELECTRICAL SAFETY

- a. **Power tool plugs must match the outlet. Never modify the plug in any way. Do not use any adapter plugs with earthed (grounded) power tools.** Unmodified plugs and matching outlets will reduce risk of electric shock.
- b. **Avoid body contact with earthed or grounded surfaces such as pipes, radiators, ranges and refrigerators.** There is an increased risk of electric shock if your body is earthed or grounded.
- c. **Do not expose power tools to rain or wet conditions.** Water entering a power tool will increase the risk of electric shock.
- d. **Do not abuse the cord. Never use the cord for carrying, pulling or unplugging the power tool. Keep cord away from heat, oil, sharp edges or moving parts.** Damaged or entangled cords increase the risk of electric shock.
- e. **When operating a power tool outdoors, use an extension cord suitable for outdoor use.** Use of a cord suitable for outdoor use reduces the risk of electric shock.
- f. **If operating a power tool in a damp location is unavoidable, use an earth leakage circuit breaker.** Use of an earth leakage circuit breaker reduces the risk of electric shock.

## 3) PERSONAL SAFETY

- a. **Stay alert, watch what you are doing and use common sense when operating a power tool. Do not use a power tool while you are tired or under the influence of drugs, alcohol or medication.** A moment of inattention while operating power tools may result in serious personal injury.
- b. **Use personal protective equipment. Always wear eye protection.** Protective equipment such as dust mask, non-skid safety shoes, hard hat, or hearing protection used for appropriate inattention while operating power tools may result in serious personal injury. conditions will reduce personal injuries.
- c. **Prevent unintentional starting. Ensure the switch is in the off-position before connecting to power source and/or battery pack, picking up or carrying the tool.** Carrying power tools with your finger on

the switch or energising power tools that have the switch on invites accidents.

- d. **Remove any adjusting key or wrench before turning the power tool on.** A wrench or a key left attached to a rotating part of the power tool may result in personal injury.
- e. **Do not overreach. Keep proper footing and balance at all times.** This enables better control of the power tool in unexpected situations.
- f. **Dress properly. Do not wear loose clothing or jewelry. Keep your hair, clothing and gloves away from moving parts.** Loose clothes, jewelry or long hair can be caught in moving parts.
- g. **If devices are provided for the connection of dust extraction and collection facilities, ensure these are connected and properly used.** Use of dust collection can reduce dust-related hazards.

#### 4) POWER TOOL USE AND CARE



- a. **Do not force the power tool. Use the correct power tool for your application.** The correct power tool will do the job better and safer at the rate for which it was designed.
- b. **Do not use the power tool if the switch does not turn it on and off.** Any power tool that cannot be controlled with the switch is dangerous and must be repaired.
- c. **Disconnect the plug from the power source and/or the battery pack from the power tool before making any adjustments, changing accessories, or storing power tools.** Such preventive safety measures reduce the risk of starting the power tool accidentally.
- d. **Store idle power tools out of the reach of children and do not allow persons unfamiliar with the power tool or these instructions to operate the power tool.** Power tools are dangerous in the hands of untrained users.
- e. **Maintain power tools. Check for misalignment or binding of moving parts, breakage of parts and any other condition that may affect the power tool's operation. If damaged, have the power tool repaired before use.** Many accidents are caused by poorly maintained power tools.
- f. **Keep cutting tools sharp and clean.** Properly maintained cutting tools with sharp cutting edges are less likely to bind and are easier to control.
- g. **Use the power tool, accessories and tool bits etc., in accordance with these instructions, taking into account the working conditions and the work to be performed.** Use of the power tool for operations different from those intended could result in a hazardous situation.

#### 5) SERVICE

**Have your power tool serviced by a qualified repair person using only identical replacement parts.** This will ensure that the safety of the power tool is maintained.

#### Symbols used in this manual

**IMPORTANT: Some of the following symbols may be used on your tool. Please study them and learn their meaning. Proper interpretation of these symbols will allow you to operate the tool better and safer.**

Symbol	Name	Designation/Explanation
V	Volt	Voltage (potential)
A	Amperes	Current
Hz	Hertz	Frequency (cycles per second)
W	Watt	Power
kg	Kilograms	Weight
min	Minutes	Time
s	Seconds	Time
∅	Diameter	Size of drill bits
n <sub>0</sub>	No load speed	Rotational speed, at no load
min <sup>-1</sup>	Revolutions per minute	Revolutions, strokes, surface speed per minute.
0	Off position	Zero speed, zero torque...
1, 2, 3, ...	Selector settings	Speed setting, higher number means greater speed
~	Alternating current	Type or a characteristic or current
	Class I construction	With electrical earth
	Warning symbol	Alerts user to warning messages

## Terminology used in the manual

1. Warning: This term means that there is a risk of physical harm or death to the operator or people nearby.
2. Caution: This term means that there is a risk of damage to the machine, cutting tool or other equipment.
3. Note: These terms offer useful information relating to the operation of the machine or its maintenance.

## SPECIFIC SAFETY RULES AND REGULATIONS

**Do not operate with dull or damaged cutting tools. This may overload the motor.**

**Protect the motor.** Never allow cutting fluid, water, or other contaminants enter the motor.

**Metal chips are often very sharp and hot.** Never touch them with bare hands. Clean up with a magnetic chip collector and a chip hook or other appropriate tool.

**CAUTION: NEVER position machine on a work piece between the electrode and the ground of any arc type welder. Damage to the machine will result, as the welder will ground through the machine's ground cable.**

**WARNING: NEVER attempt to use machine with incorrect current or abnormally low voltage. Check machine nameplate to ensure that correct voltage and Hz are used.**

## UNPACKING

Carefully remove the tool and all loose items from the shipping container. Retain all packing materials until after you have inspected and satisfactorily operated the machine.

**DO NOT OPERATE THIS TOOL UNTIL YOU READ AND FULLY UNDERSTAND THE ENTIRE INSTRUCTION MANUAL.**

## HOLE CUTTING MACHINE INSPECTION

Inspect your hole cutting machine periodically to prevent malfunction and potential accident from happening.

1. Check for functionality of the switch, do not operate a tool that can not be controlled by switch.
2. Inspect the power cord, ground prong, and plug carefully for any damage. Always make sure the cord is intact before performing any operation, failure to comply might lead to electric shock!
3. Clean scrap, grease or dirt after every use. This helps to prolong the durability of the tool and reduce the risk of injury.
4. Check cutting edges before every use, and replace when cutting edges worn out. Dull or damaged cutting edges not only could lead to tool breakage, excessive buildup to the work piece, or even lead to injury.
5. Only use accessories recommended for the tool. Accessories from other tools might be hazardous or even cause serious injury while operating!

## INSTRUCTION TO SET UP HOLE CUTTING TOOL

Unplug the power plug from mains and make sure the switch is OFF before setting up the machine.

Always make sure the working pipe is de-pressurized before performing any operation!

Do not lift hole cutting machine above your shoulder, serious injury or damage to the machine might be result from loss of balance.

1. Place hole cutting machine on the ground or on flat surface. Select desired hole saw and fasten to the arbor before mounting the machine to the working pipe.
2. Place machine on top of the working pipe. After determined desired location for hole cutting, ensure the chain assembly hold the pipe as tight as possible, and allow the chain to fall into the notch on the other side of the body casting.
3. Use the swivel lever to fasten the machine as tight as possible to the working pipe.



## SWITCHING ON AND OFF THE HOLE CUTTING MACHINE

**Warning! Check for functionality of the switch, do not operate a tool that can not be controlled by switch.**

Make sure the hole cutting machine is properly fastened to the working pipe.

Adjust the side handle to either left or right hand side according to

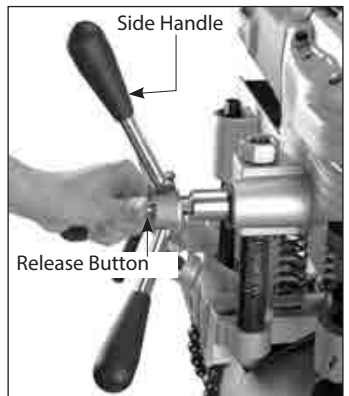

user's need. If it is required to mount the crank lever on the opposite side or to change its position, push the Release Button in the center of the Crank Hub and remove. Press the Button and mount on the opposite side or in the desired position.

Start hole cutting by pushing green button ON.

**STEEL SCRAP WILL BECOME HOT AFTER HOLE CUTTING PROCESS, DO NOT TOUCH THE STEEL SCRAP IMMEDIATELY AFTER CUTTING!**

After finished hole cutting, push red button OFF to stop the hole cutting machine.

**CAUTION: Unplug the power plug from mains and make sure the switch is OFF before pushing out the steel scrap .**

Push out steel scrap by using flat-head screwdriver or other proper and safe tool.

## BUBBLE LEVEL

A bubble level is equipped in the rear base of the hole cutting machine. The bubble level is designed to ensure the aligning of serial hole cuttings. Using the bubble level for horizontal or vertical drilling , adjust the working pipe or cutting machine to achieve a good level positioning, then fully tighten the swivel lever to fasten the machine as tight as possible to the working pipe.



## OPERATION

**MAKE SURE FULLY UNDERSTANDING OF THE INSTRUCTION MANUAL BEFORE OPERATING THE MACHINE.**

**WEAR GOGGLES TO PREVENT STEEL SCRAP SHOOTING INTO EYES OR CAUSING OTHER INJURY. ALWAYS DRESS PROPERLY AND WEAR PROTECTIONS BEFORE PERFORMING THE OPERATION.**

**Warning!! Always make sure the pipe is de-pressurized before performing any operation!**

1. After switching on the machine, applying pressure to the hole saw slowly rotating the handle downward.
2. Do not overfeed the hole saw. Allow the hole saw to decide the speed of cutting, experienced operator should be able to cut through without applying excessive pressure to the hole saw.

**DO NOT TOUCH THE SCRAP OR HOLE SAW IMMEDIATELY AFTER CUTTING, THE SCRAP AND HOLE BLADE WILL BECOME HOT DURING CUTTING AND MIGHT LEAD TO SERIOUS INJURY!**

3. After hole saw cut through the pipe, rotate the handle reversely or allow the spring to push the hole saw to original position.

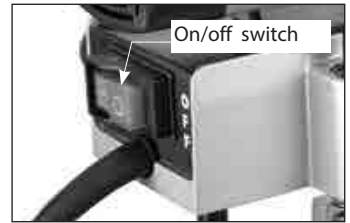

**SWITCH OFF THE MACHINE IMMEDIATELY AFTER USE TO PREVENT ACCIDENT OR OPERATE BY UNTRAINED PERSONNEL!**

## **MAINTENANCE**

Every 50 hours of operation blow compressed air through the motor while running at no load to clean out accumulated dust. (If operating in especially dusty conditions, perform this operation more often.)

Clean scrap after every use and make sure frictional metal parts are well lubricated to prevent rusty!

## **THE ARBOR SHAFT**

Keep the arbor shaft free of dirt and lightly grease as needed. If the mechanism noisy, it may be dirty or have a chip lodged in it. Clean and re-grease as needed.

## **THE CARBON BRUSHES**

The carbon brushes are a normal wearing part and must be replaced when they reach their wear limit.

**Caution: Always replace the brushes as a pair.**

### **To replace:**

1. Remove the 4 screws and remove the motor tail cover.
2. Using pliers rotate the brush spring out of the way and slide the old carbon brush out of the brush holder.
3. Unscrew the screw to remove the brush lead. The old carbon brush may now be lifted away.
4. Install a new brush. Installation is the reverse of removal.
5. Replace the motor tail cover.



## **CARBON BRUSHES**

Due to the brush design, if the machine comes to a stop without any reason, the brushes have to be checked. The brush design stops the machine before the carbon brushes are finished and protects the motor.

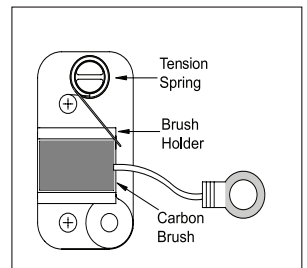

**If the replacement of the power supply cord is necessary, this has to be done by the manufacturer or their agent in order to avoid a safety hazard.**

**WARNING: All repairs must be entrusted to an authorized service center.** Incorrectly performed repairs could lead to injury or death.



# WIRING

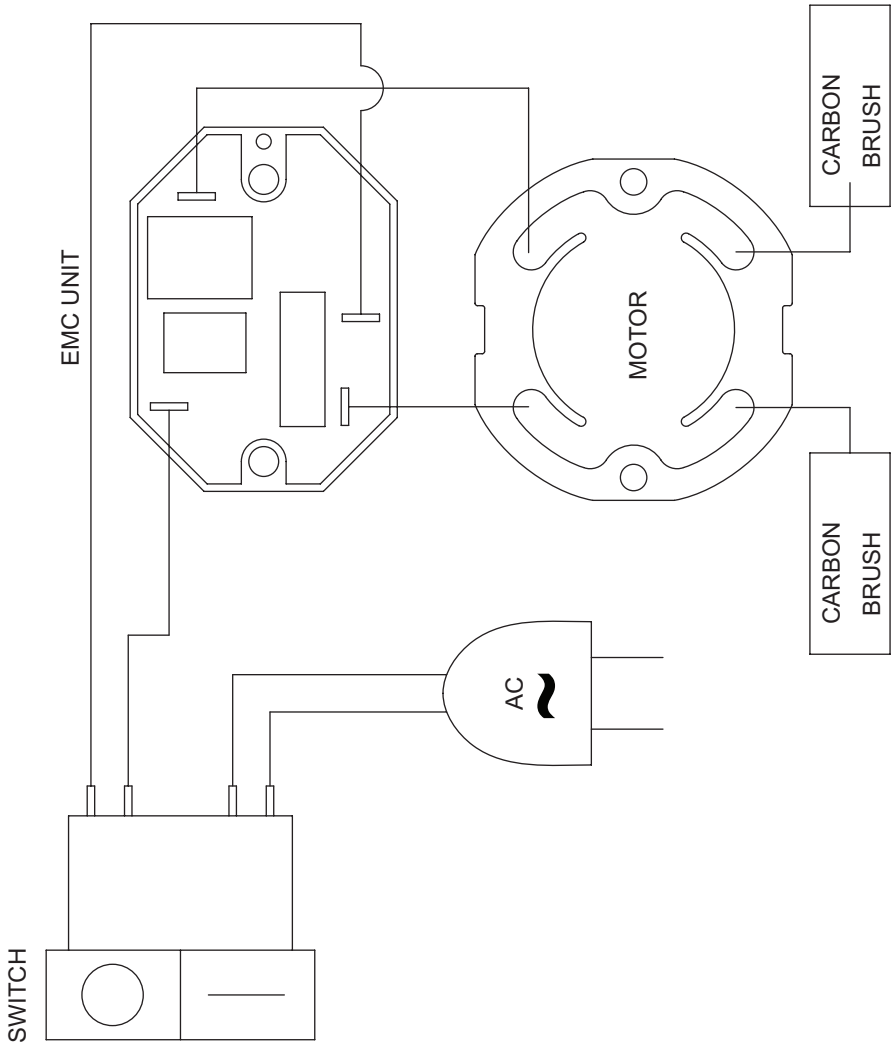

# Exploded View

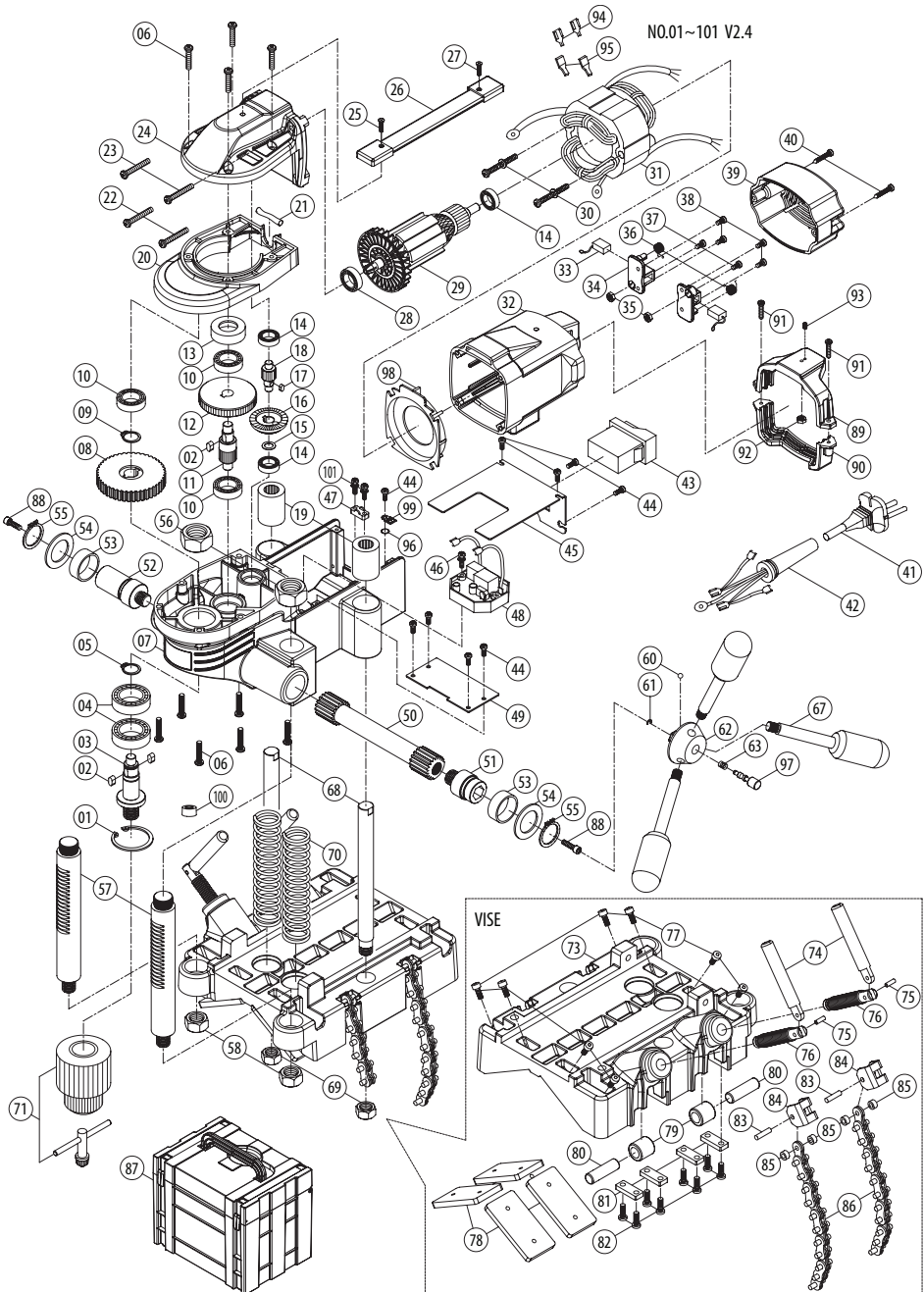

## Parts list

NO.	Parts Name	QTY	NO.	Parts Name	QTY
1	INTERNAL CIRCLIP R-40	1	50	CRANK SPINDLE	1
2	PARALLEL KEY 5 x 5 x 10	3	51	CRANK SPINDLE CASING(L) M14 x P2.0	1
3	SPINDLE 5/8"-16	1	52	CRANK SPINDLE CASING(S) M14 x P2.0	1
4	BEARING 6203-2NSE	2	53	CRANK BUSHING Ø28 x Ø32 x 12	2
5	EXTERNAL CIRCLIP S-17	1	54	THRUST WASHER Ø25.5 x Ø40 x 2	2
6	SCREW M5 x 25	10	55	EXTERNAL CIRCLIP S-25	2
7	GEAR CASE	1	56	NUT M20 x P1.5	2
8	OUTPUT GEAR M1.5 x 44T	1	57	COLUMN	2
9	EXTERNAL CIRCLIP S-15	1	58	NUT M14 x P2.0	2
10	BEARING 6200 zz	3	59	N/A	-
11	INTERMEDIATE GEAR PINION M1.5 x 9T	1	60	CHECK BALL Ø5	1
12	INTERMEDIATE GEAR M1.25 x 47T	1	61	E-CLIP E-3	1
13	BUSHING Ø30 x Ø36 x 11	1	62	CRANK HUB	1
14	BALL BEARING 608 zz	3	63	SPRING Ø0.6 x Ø4.1 x Ø5.3 x 4T x 8.5L	1
15	THRUST WASHER Ø10.1 x Ø14 x 1	1	64~66	N/A	-
16	BEVEL GEAR M1.0 x 46T	1	67	GRIP	3
17	PARALLEL KEY 4 x 4 x 7	1	68	TELESCOPIC ROD	2
18	INPUT PINION M1.25 x 9T	1	69	NUT M12 x P1.75 x 7mm	2
19	LINEAR BEARING Ø16 x Ø28 x 37	2	70	SPRING Ø3 x Ø23 x Ø29 x 16T x 160L	2
20	GEAR CASE	1	71	CHUCK 5/8"-16	1
21	SEAL 5cm	1	72	N/A	-
22	SCREW M5 x 25	2	73	BODY CASTING	1
23	SCREW M5 x 30	2	74	SWIVEL LEVER	2
24	GEAR COVER	1	75	SPRING PIN	2
25	FLAT HEAD SCREW M5 x 15	1	76	WISE SCREW	2
26	STRAP	1	77	SCREW M5 x 12	8
27	FLAT HEAD SCREW M5 x 20	1	78	TABLE PLATE	4
28	BEARING 6001-LLU	1	79	DRIVE GUIDE ROLLER Ø12 x Ø20 x 20	2
29	ARMATURE M1.0 x 6T	1	80	ROLLER AXLE Ø12 x 40	2
30	SCREW M5 x 60	2	81	ROLLER PLATE	4
31	STATOR	1	82	SCREW M5 x 16	8
32	MOTOR HOUSING	1	83	SPRING PIN Ø5 x 20	2
33	CARBON BRUSH 7 x 11 x 17	2	84	CHAIN SHACKLE BRACKET	2
34	BRUSH HOLDER	2	85	SPACER Ø5.1 x Ø9 x 4.8	4
35	NUT M4 x 8	2	86	CHAIN	2
36	BRUSH SPRING	2	87	CARRY CASE	1
37	SCREW M4 x 10	2	88	SOCKET CAP SCREW M5 x 16	2
38	SCREW M4 x 12	4	89	BRACKET-TOP	1
39	MOTOR TAIL COVER	1	90	BRACKET-BOTTOM	1
40	SCREW M4 x 25	2	91	SCREW M4 x 16	2
41	POWER SUPPLY CABLE	1	92	NUT M5	1
42	CORD ARMOR	1	93	SCREW M4 x 8	1
43	MOTOR SWITCH 110V	1	94	SPADE TERMINAL	2
43	MOTOR SWITCH 220V	1	95	TERMINAL COVER	2
44	SCREW M4 x 8	9	96	STAR WASHER M5	1
45	SWITCH BRACKET	1	97	PLUNGER	1
46	SCREW M4 x 16	1	98	FAN SHROUD	1
47	CABLE CLIP	1	99	EARTHING MARKING	1
48	OVERLOAD UNIT 110V	1	100	BULL'S EYE LEVEL	1
48	OVERLOAD UNIT 220V	1	101	SCREW	2
49	MOUNTING PLATE	1			

